



# GRTN



**I** La bocchetta in gomma modello GRTN (Gas Rubber Truck Nozzle) presenta una bocca di aspirazione con diametro di 185 mm e una struttura robusta per adattarsi perfettamente agli impieghi gravosi delle officine camion. Il prodotto è stato ottimizzato per accogliere la serranda di chiusura stagna all'interno del corpo bocchetta unitamente alla griglia anti intrusione; in questo modo il prodotto rimane compatto e flessibile per potersi collegare anche a marmitte difficili da raggiungere. La bocchetta GRTN è configurata con varie tipologie di pinza per adattarsi ad ogni esigenza di fissaggio.

**UK** The GRTN (Gas Rubber Truck Nozzle) rubber nozzle has a 185 mm wide suction intake and a robust design to perfectly fit the heavy duty truck application. The product has been optimized to accommodate the fully tight closing valve inside the nozzle body, together with the protection net; in this way, the product remains compact and flexible so that it can also be connected to mufflers difficult to reach. The GRTN nozzle is configured with various types of grippers to fit every need of exhaust pipe fastening.

 L'entonnoir en caoutchouc GRTN (Gas Rubber Truck Nozzle) a une bouche d'aspiration de 185 mm de diamètre et une conception robuste pour s'adapter parfaitement au travail dans les ateliers PL.

Le produit a été optimisé pour accueillir la soupape étanche à l'intérieur du corps en caoutchouc avec la grille anti-intrusion; de cette façon, le produit reste compact et flexible de sorte qu'il peut également être connecté aux pots d'échappement difficiles à atteindre.

L'entonnoir GRTN est configuré avec différents types de pinces pour s'adapter à tous les besoins de fixation.

 Die GRTN (Gas Rubber Truck Nozzle) Gummi-Trichter hat eine Saugöffnung von 185 mm Durchmesser und ein robustes Design, um die schwere Lkw-Arbeit perfekt zu erfüllen.

Das Produkt wurde optimiert, um die dichte Absperrklappe innerhalb des Trichterkörpers zusammen mit dem Anti-Einbruchgitter aufzunehmen; auf dieser Weise bleibt das Produkt kompakt und flexibel, so dass es auch an schwer zugängliche Auspuff-Anlage angeschlossen werden kann.

Die GRTN Trichter ist mit verschiedenen Greifertypen für jeden Befestigungsbedarf konfiguriert.

 El boquerel en goma GRTN (Gas Rubber Truck Nozzle) tiene una boca de aspiración de 185 mm de diámetro y un diseño robusto para encajar perfectamente en el trabajo pesado de un taller camión.

El producto ha sido optimizado para alojar un tapa de cierre dentro del cuerpo del boquerel junto con la rejilla antiintrusión; de esta manera el producto permanece compacto y flexible de modo que también puede conectarse a escapes de difícil acceso.

El boquerel GRTN está configurado con varios tipos de pinzas para adaptarse a todas las necesidades de fijación.

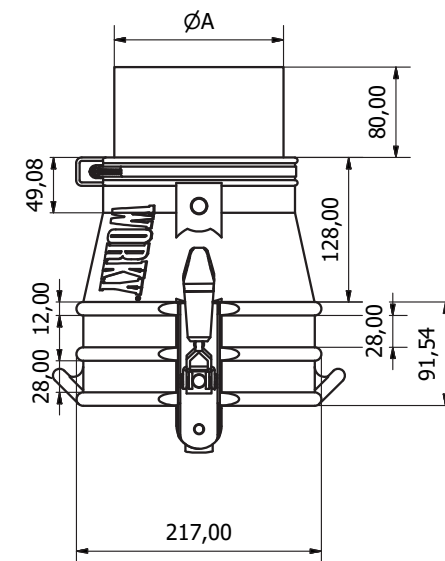
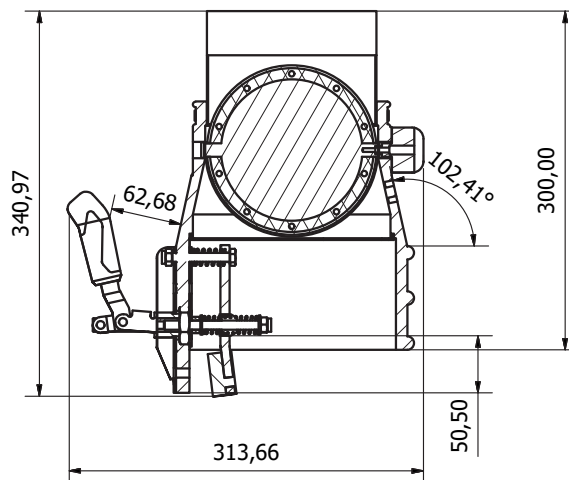
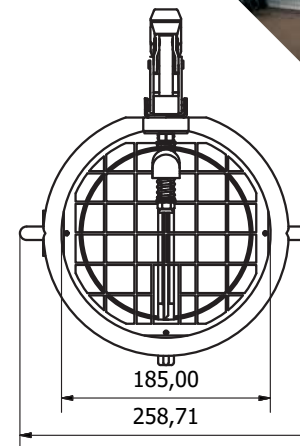



# GRTN



GRTN	Ø
GRTN-75	75 mm
GRTN-100	100 mm
GRTN-125	125 mm
GRTN-150	150 mm

 Bocchetta in gomma per impieghi gravosi con rete anti intrusione, serranda a tenuta stagna inclusa nel corpo della bocchetta e bocca di aspirazione da 185 mm.

 Heavy duty rubber nozzle with fully tight closing valve included in the body of the product, protection net and suction intake diam 185 mm.

 Entonnoir en caoutchouc pour PL avec soupape étanche inclus dans le corp du produit, réseau anti-intrusion et bouche aspirante de 185 mm de diamètre.

 Gummitrichter für LKW mit Schutzgitter, dichter Absperrklappe im Trichterkörper integriert und Saugöffnung DN 185 mm.

 Boquerel en goma para vehiculos pesados con rejilla anti-intrusión, tapa de cierre incluida en el cuerpo del producto y boca de aspiración de 185 mm de diámetro.

# GRTN-K





GRTN-K	Ø
GRTN-100K	100 mm
GRTN-125K	125 mm
GRTN-150K	150 mm

 Bocchetta in gomma per impieghi gravosi con rete anti intrusione, serranda a tenuta stagna inclusa nel corpo della bocchetta, clip di fissaggio al tubo di scarico e bocca di aspirazione da 185 mm.

 Heavy duty rubber nozzle with fully tight closing valve included in the body of the product, protection net, clip for fixing to the exhaust pipe and suction intake diam 185 mm.

 Entonnoir en caoutchouc pour PL avec soupape étanche inclus dans le corp du produit, réseau anti-intrusion, clip de fixation au pot d'échappement et bouche aspirante de 185 mm de diamètre.

 Gummitrichter für LKW mit Schutzgitter, dichter Absperrklappe im Trichterkörper integriert, Befestigungsclips und Saugmund DN 185 mm.

 Boquerel en goma para vehiculos pesados con rejilla anti-intrusión, tapa de cierre incluida en el cuerpo del producto, clip de fijación y boca de aspiración de 185 mm de diámetro.

# GRTN-MG





GRTN-MG	Ø
GRTN-100MG	100 mm
GRTN-125MG	125 mm
GRTN-150MG	150 mm

 Bocchetta in gomma per impieghi gravosi con rete anti intrusione, serranda a tenuta stagna inclusa nel corpo della bocchetta, pinza gommata di fissaggio al tubo di scarico e bocca di 185 mm.

 Heavy duty rubber nozzle with fully tight closing valve included in the body of the product, protection net, vulcanized clamp for fixing to the exhaust pipe and suction intake diam 185 mm.

 Entonnoir en caoutchouc pour PL avec soupape étanche inclus dans le corp du produit, réseau anti-intrusion, pince vulcanisée de fixation au pot d'échappement et bouche aspirante de 185 mm de diamètre.

 Gummitrichter für LKW mit Schutzgitter, dichter Absperrklappe im Trichterkörper integriert, vulkanisierte Klemme und Saugmund DN 185 mm.

 Boquerel en goma para vehiculos pesados con rejilla anti-intrusión, tapa de cierre incluida en el cuerpo del producto, mordaza vulcanizada y boca de 185 mm de diámetro.

# GRTN-EG



GRTN-IG	Ø
GRTN-100EG	100 mm
GRTN-125EG	125 mm
GRTN-150EG	150 mm

 Bocchetta in gomma per impieghi gravosi con pinza interna ad espansione e bocca di 185 mm.

 Heavy duty rubber nozzle with internal expanding clamp and suction intake diam 185 mm.

 Entonnoir en caoutchouc pour PL avec pince interne a expansion et bouche aspirante de 185 mm de diamètre.

 Gummitrichter für LKW mit Innenverbreitungsklemme und Saugöffnung DN 185 mm.

 Boquerel en goma para vehiculos pesados con mordaza interna a expansión y boca de 185 mm de diámetro.

# GRTN-M





GRTN-M	Ø
GRTN-100M	100 mm
GRTN-125M	125 mm
GRTN-150M	150 mm

 Bocchetta in gomma per impieghi gravosi con rete anti intrusione, serranda a tenuta stagna inclusa nel corpo della bocchetta, magneti di fissaggio al tubo di scarico e bocca di 185 mm.

 Heavy duty rubber nozzle with fully tight closing valve included in the body of the product, protection net, magnets for fixing to the exhaust pipe and suction intake diam 185 mm.

 Entonnoir en caoutchouc pour PL avec soupape étanche inclus dans le corp du produit, réseau anti-intrusion, aimants de fixation au pot d'échappement et bouche aspirante de 185 mm de diamètre.

 Gummitrichter für LKW mit Schutzgitter, dichter Absperklappe im Trichterkörper integriert, Magneten und Saugmund DN 185 mm.

 Boquerel en goma para vehiculos pesados con rejilla anti-intrusión, tapa de cierre incluida en el cuerpo del producto, imanes de fijación y boca de aspiración de 185 mm de diámetro.

# GMN-E6K7I



GMN	Ø GT2	Ø conn.
GMN-E6K7I	200 mm	150 mm

 Bocchetta flessibile diam. 200 mm per collegarsi agli scarichi centrali sottoscocca secondo specifiche MERCEDES K71/C.

 Special flexible nozzle diam 200 mm for exhaust extraction from EURO 6 MERCEDES industrial vehicles with central exhaust pipe.

 Entonnoir flexible diam 200 mm pour l'aspiration des gaz d'échappement des MERCEDES EURO 6 poids lourds avec sortie centrale.

 Flexibler Adaptor DN 200 mm für EURO 6 MERCEDES LKW mit zentrale Auspuff.

 Boquerel específico para vehiculos pesados MERCEDES EURO 6 con escape central.