



GROLLY



I Gli aspiratori carrellati della linea GROLLY sono la soluzione ideale per evacuare i gas di scarico prodotti da veicoli con singolo o doppio scarico. Il sistema non prevede installazione alcuna e i fumi aspirati sono convogliati fuori dall'edificio attraverso un tubo flessibile di 10 mt. L'estrema maneggevolezza e facilità d'uso fanno di GROLLY la soluzione ideale per officine temporanee, musei di auto storiche, garage privati o locali tecnici che abbiano vetture con motore acceso.

UK The GROLLY line mobile extraction systems are perfect to extract exhaust gases from single or twin pipe vehicles. No installation is required, and the exhaust gases are channelled out of the building through a 10mt flexible hose. Simple handling and user-friendly features make GROLLY the ideal solution for temporary workshops, classic car museums, private garages, or any technical room where there are vehicles with the engine running.

 Les aspirateurs mobiles de la ligne GROLLY sont la solution idéale pour évacuer les gaz d'échappement produits par les véhicules avec pots d'échappement simples ou doubles. Le système ne prévoit aucune installation et le gaz aspiré est acheminé hors du bâtiment par un tuyau de 10 Mt. L'extrême maniabilité et la facilité d'utilisation font de GROLLY la solution idéale pour les ateliers temporaires, les musées de voitures historiques, les garages privés ou les locaux techniques où les voitures ont le moteur en marche.

 Die GROLLY Mobilabsauger sind die ideale Lösungen, um die Abgase von Fahrzeuge mit Einzel- oder Doppelauspuff zu entfernen. Das System braucht keine Installation und die abgesaugte Abgase sind durch einen 10mt Schlauch im Freien luft gebracht. Dank der extremen Handlichkeit und der sehr einfachen Benutzung, ist GROLLY eine geeignete Lösung für vorläufigen Werkstätte, Museen von Oldtimers, privaten Garagen oder technischen Räume mit Fahrzeuge mit laufendem Motor.

 Los extractores móviles de la línea GROLLY son la solución ideal para evacuar los gases de escape producido por vehículos con escape simple y doble. El sistema no necesita instalación y los gases son expulsado fuera del edificio a través de una manguera flexible de 10 mt. Extremadamente fácil de usar y manejable, GROLLY es la solución ideal para talleres temporales, museos históricos de automóviles, garajes privados o instalaciones técnicas que tienen vehículos motorizados.

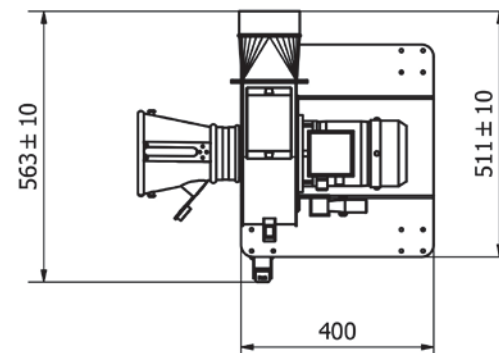
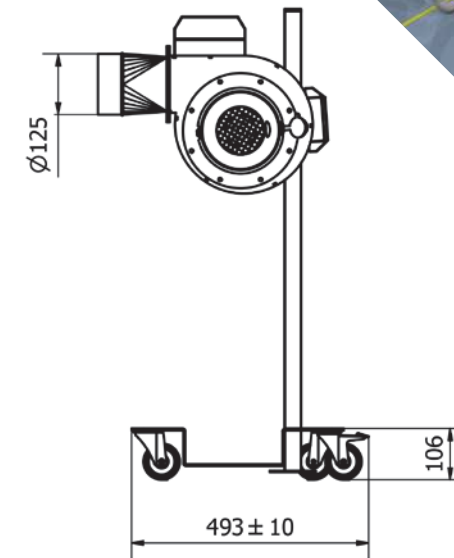
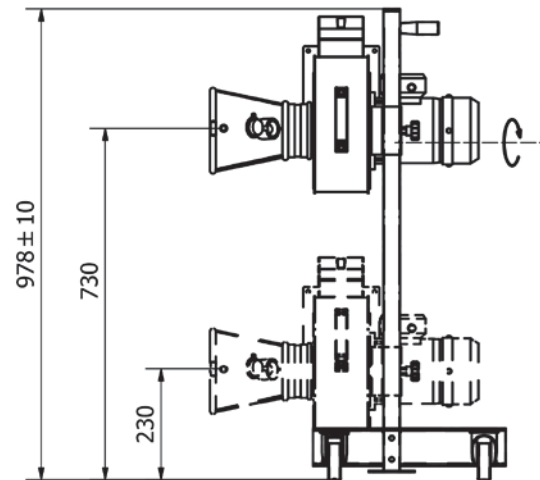
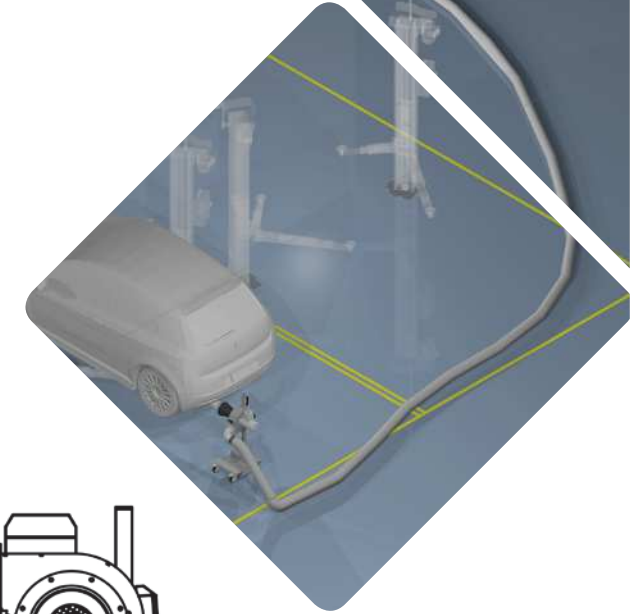



GROLLY



GROLLY	HP	V	HZ	Phases	on/off
GROLLY	0,5	400	50	3	✓
GROLLY-60HZ	0,5	400	60	3	✓
GROLLY-230M	0,5	230	50	1	✓
GROLLY-230T	0,5	230	50	3	✓

 Aspiratore portatile con motore da 0,5 Hp regolabile in altezza con bocchetta in gomma direttamente accoppiata.

 Height-adjustable mobile system with 0,5 Hp motor and rubber nozzle.

 Aspirateur mobile avec moteur de 0,5 HP réglable en hauteur avec entonnoir en caoutchouc.

 Höhenverstellbarer Mobilabgasventilator für PKW mit 0,37 kw Motor, mit eingebautem Gummitrichter.

 Aspirador móvil para turismos con motor de 0,5 Hp regulable en altura y boquerel en goma instalado directamente a la estructura.

GROLLY-M



GROLLY-M	HP	V	HZ	Phases	on/off	extra
GROLLY-M	0,5	400	50	3	✓	
GROLLY-M230M	0,5	230	50	1	✓	
GROLLY-M110M60HZ	0,5	110	60	1	✓	ul-csa
GROLLY-M240M60HZ	0,5	240	60	1	✓	
GROLLY-M-WN	0,5	400	50	3	✓	no GRN

 Aspiratore portatile con motore da 0,5 Hp regolabile in altezza con bivio ad Y e doppia bocchetta in gomma con mensola per sostenere i tubi a riposo.

 Height-adjustable mobile system with 0,5 Hp motor, Y piece with rubber nozzles, and bracket to stow the hoses.

 Aspirateur mobile avec moteur de 0,5 HP réglable en hauteur avec Y et deux entonnoirs en caoutchouc avec console pour les tuyaux.

 Höhenverstellbarer Mobilabgasventilator mit 0,37kw Motor, Y-Stück mit zwei Gummitrichter und Schlauchhalterung.

 Aspirador móvil para turismos con motor de 0,5 Hp regulable en altura; Y con dos boquereles en goma y soporte para mangueras.

GROLLY-V



GROLLY-V	HP	V	HZ	Phases	on/off	extra
GROLLY-V	1	400	50	3	✓	
GROLLY-V230M	1	230	50	1	✓	
GROLLY-V110M60HZ	1	110	60	1	✓	ul-csa
GROLLY-V230M60HZ	1	230	60	1	✓	

 Aspiratore portatile con motore da 1 Hp regolabile in altezza con bocchetta in gomma direttamente accoppiata.

 Height-adjustable mobile system with 1 Hp motor and rubber nozzle.

 Aspirateur mobile avec moteur de 1 HP réglable en hauteur avec entonnoir en caoutchouc.

 Höhenverstellbarer Mobilabgasventilator mit 0,75kw Motor, mit eingebautem Gummitrichter.

 Aspirador móvil con motor de 1 Hp regulable en altura y boquerel en goma instalado directamente a la estructura.

GROLLY-T



GROLLY-T	HP	V	HZ	Phases	on/off	extra
GROLLY-T	1,5	400	50	3	✓	
GROLLY-TM	1,5	230	50	1	✓	
GROLLY-T110M60HZ	1,5	110	60	1	✓	ul-csa
GROLLY-TGT5	1,5	400	50	3	✓	500°C

 Aspiratore portatile con motore da 1,5 Hp dotato di braccio regolabile in altezza per sostenere la bocchetta e il flessibile diam 150 mm.

 Mobile system with 1,5 Hp motor, equipped with an adjustable arm to hold the steel nozzle diam. 150 mm.

 Aspirateur mobile avec moteur de 1,5 HP équipé par bras réglable en hauteur pour soutenir l'entonnoir et le flexible diam 150 mm.

 Beweglicher Abgasventilator mit 1,1 kw Motor, mit verstellbarem Arm mit Trichter und DN150 mm Schlauch ausgestattet.

 Aspirador móvil con motor de 1,5 Hp equipado con brazo regulable para el soporte del boquerel y manguera Ø150mm.

GROLLY-YA



GROLLY-YA	HP	V	HZ	Phases	on/off	extra
GROLLY-YA	1	400	50	3	✓	
GROLLY-YAWN	1	400	50	3	✓	no GRTN

 Aspiratore portatile con motore da 1 Hp regolabile in altezza e dotato di due bracci indipendenti per sostenere le bocchette in gomma per vetture sportive.

 Portable extraction system with 1 Hp motor and a structure with 2 independent supporting arms equipped with two rubber nozzles for sports cars.

 Aspirateur mobile avec moteur de 1 HP réglable en hauteur et équipé par deux bras indépendents pour soutenir les entonnoirs en caoutchouc pour voitures des sport.

 Höhenverstellbarer beweglicher Abgasventilator mit 0,75kw Motor, ausgestattet mit zwei selbstständigen Arme für die Unterstutzung der Gummitrichter für sportlichen PKWs.

 Aspirador móvil de 1 Hp equipado con dos brazos para soportar dos boquereles en goma para turismos deportivos.

GROLLY-GTP



GROLLY-GTP	L.	Ø	GROLLY
GROLLY-GTP12510	10 m	130 mm	GROLLY / M
GROLLY-GTP15010	10 m	150 mm	GROLLY-V / T / YA

 Tubo flessibile leggero in pvc con spirale metallica lungo 10 mt per espellere i gas aspirati dai GROLLY.

 Flexible hose PVC coated with steel helix suitable as expulsion pipe for GROLLYs. 10 mt long and available in two diameters.

 Tuyau flexible en PVC avec spire métallique longueur 10 mt pour refoulement de gaz d'échappement aspiré par les GROLLY.

 10mt PVC Schlauch mit Stahlspiral, um die Abgase vom GROLLY auszublasen.

 Manguera flexible en PVC con espiral metálica, 10mt de longitud, para expulsar los gases extraídos por el GROLLY.