





# GERF / T

 Gli arrotolatori motorizzati con aspiratore accoppiato della serie GERF (con pulsantiera) e GERFT (con telecomando) sono progettati per arrotolare il tubo flessibile con la semplice pressione di un tasto. Il motore elettrico interno, dotato di grande potenza, si adatta a tutte le lunghezze e i diametri in gamma senza problemi. Entrambe le versioni GERF e GERFT sono dotate di microinterruttore che può comandare la partenza dell'aspiratore accoppiato solo aggiungendo il dispositivo GEMC (opzionale). L'aspiratore della serie GSA può essere ruotato in 8 posizioni differenti ed è già dimensionato per un'aspirazione ottimale.

 The GERF (with push button) and the GERFT (with remote control) motor driven hose reels with integrated fan are designed to be rolled up and unrolled just by pushing a button. The internal motor, thanks to its great power, is suitable for any hose length or diameter. Both GER and GERT versions are equipped with a microswitch that can start the integrated fan just by adding a device called GEMC (optional). The GSA fan can be rotated in 8 different positions and it has been sized to ensure the best performance.

 Les enrouleurs motorisés avec un aspirateur couplé de la série GERF (avec boîtier à boutons) et GERFT (avec télécommande) sont conçues pour enrouler le tuyau avec la simple pression d'un bouton. Le moteur électrique interne, de grande puissance, s'adapte à toutes les longueurs et diamètres de la gamme sans aucun problème. Les deux versions GERF et GERFT sont équipées d'un micro interrupteur qui peut contrôler le démarrage de l'aspirateur couplé uniquement en ajoutant le dispositif GEMC (optionnel). L'aspirateur de la série GSA peut être tourné en 8 positions différentes et est déjà dimensionné pour une aspiration optimale

 Die motorbetriebenen Schlauchaufrollen mit gekoppelten Ventilator GERF (mit Druckknopf) und GERFT (mit Fernbedienung) sind so entwickelt worden, dass der Schlauch nur durch den Knopfdruck einrollt. Der innere Elektromotor mit großer Leistung passt problemlos in alle Schlauchlänge und Durchmesser. Sowohl GERF- als auch GERFT-Versionen verfügen über einen Mikroschalter zur Steuerung des automatischen Starts des Zentralventilators dank dem GEMC-Gerät (optional). Der Ventilator der GSA-Serie kann in 8 verschiedenen Positionen gedreht werden und ist für optimale Absaugung bereits dimensioniert.

 Los enrolladores motorizados con aspirador acoplado de la serie GERF (con botón pulsador) y GERFT (con mando a distancia) están diseñados para enrollar la manguera simplemente presionando un botón. El motor eléctrico interno, con gran potencia, se adapta a todas las longitudes y diámetros de manguera sin ningún problema. Ambas versiones GERF y GERFT cuentan con un microinterruptor que puede comunicar con el aspirador para la marcha y paro, simplemente añadiendo el dispositivo GEMC (opcional). El aspirador de la serie GSA se puede rotar en 8 posiciones diferentes y ya está dimensionado para una extracción óptima.





# GERFT

 I GERFT hanno un manicotto di rinforzo dentro al tubo nel punto più soggetto a schiacciamento, così le performances durano tutta la vita.

 The GERFTs have a reinforcement sleeve inside the hose at the most crush-suffering point, so the performances last for a lifetime.

 Les GERFT ont un manchon de renforcement à l'intérieur du tuyau au point le plus sujet à l'écrasement, donc les performances durent toute une vie.

 Gli arrotolatori GERFT sono equipaggiati con tubo armato antischiacciamento resistente fino a 200°C di temperatura massima.

 The GERFT hose reels are equipped with an armoured crushproof flexible hose resistant up to 200° C.

 Les enrouleurs GERFT sont équipés par un tuyau anti-écrasement résistant jusqu'à 200°C

 Gli arrotolatori GERFT hanno il fermatubo di sicurezza integrato nel motore di arrotolamento e una fascetta all'estremità del tubo già in dotazione.

 The safety stopper of the GERFT hose reels is integrated into the rolling motor and includes a hose clamp at the end of the hose.

 Les enrouleurs GERFT sont munis d'un arrêt de fin de course avec système antidérapant et d'un collier à l'extrémité du tuyau.

 I GERFT possono essere montati a soffitto, a parete e a pavimento, sempre mantenendo le migliori prestazioni.

 The GERFTs can be fixed to ceiling, wall and floor, always maintaining the best possible performance.

 Les GERFT peuvent être installés au plafond, au mur et au sol, en conservant toujours les meilleures performances.

Product Plus

 La struttura in acciaio zincato è verniciata a polvere epossidica nel colore grigio RAL 7040.

 The galvanized steel structure is epoxy powder coated in the color grey RAL 7040.

 La structure en acier galvanisé est vernie en poudre époxy dans la couleur gris RAL 7040.

 I possibili accessori sono: bocchette per collegarsi alle marmitte delle auto, quadri di partenza automatica dell'aspiratore, staffe universali di fissaggio.

 The possible accessories are: nozzles for connecting to the car mufflers, automatic fan starters, universal fastening brackets.

 Les accessoires disponibles sont: les entonnoirs pour les différents pots d'échappement, coffrets démarrage automatique de l'aspirateur, étriers universels de fixation.





# GERFT

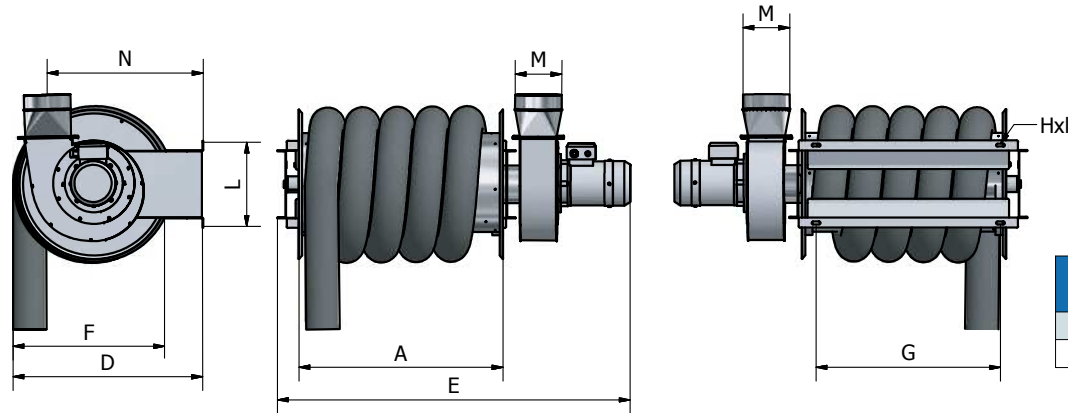
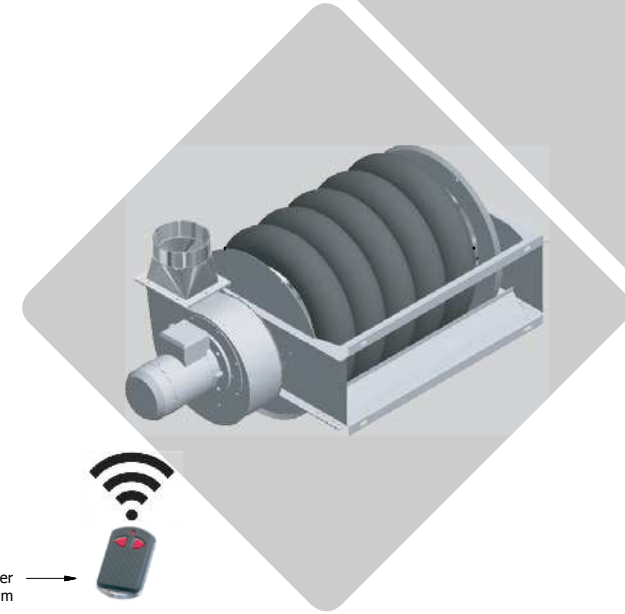

Rewinding engine	Voltage	Power consumption	Current consumption	Lifting Power
214.12M1-50Hz	230 V	450 W	2 A	145 kg
* 73220000-50Hz	230 V	1400W	6 A	328 kg

	ø[mm]	L.[m]	HP/kW	A[mm]	D[mm]	E[mm]	F[mm]	G[mm]	Hxl[mm]	L[mm]	M[mm]	N[mm]	Kg	Kg Comp.
GERFT757.5	75	7.5	0,5/0,35	680	640	1160	528	2x339.5	20x13	274	ø125	376	34	41
GERFT7510	75	10	0,5/0,35	680	640	1330	528	2x339.5	20x13	274	ø125	376	39	50
GERFT7512.5	75	12.5	0,5/0,35	850	809	1237	650	2x404	20x13	324	ø125	484	48	59
GERFT7515	75	15	0,5/0,35	850	848	1407	730	3x360	20x13	324	ø125	484	51	62
GERFT1007.5	100	7.5	0,5/0,35	680	690	1160	578	2x339.5	20x13	274	ø125	401	34	45
GERFT10010	100	10	0,5/0,35	850	690	1320	578	2x404	20x13	274	ø125	401	39	51
GERFT10012.5	100	12.5	0,5/0,35	1080	823	1637	678	3x360	20x13	324	ø125	484	51	62
GERFT10015	100	15	1/0,75	1080	848	1637	730	3x360	20x13	324	ø160	484	61	72
GERFT1257.5	125	7.5	1/0,75	680	848	1237	730	2x339.5	20x13	324	ø160	484	53	64
GERFT12510	125	10	1/0,75	850	848	1407	730	2x404	20x13	324	ø160	484	56	67
GERFT12512.5	125	12.5	1/0,75	1080	848	1637	730	3x360	20x13	324	ø160	484	61	68
GERFT12515	125	15	1/0,75	1080	848	1637	730	3x360	20x13	324	ø160	484	64	71
GERFT1507.5	150	7.5	1/0,75	680	898	1237	780	2x339.5	20x13	324	ø160	484	61	74
GERFT15010	150	10	1/0,75	850	898	1407	780	2x404	20x13	324	ø160	509	56	67
GERFT15012.5	150	12.5	1/0,75	1080	898	1637	780	3x360	20x13	324	ø160	509	61	81
GERFT15015	150	15	1/0,75	1272	898	1829	780	3x445	20x13	324	ø160	509	66	91
GERFT20010*	200	10	2/1,5	1280	1295	1944	1080	3x474	20x13	501	ø200	755	160	207
GERFT20015*	200	15	2/1,5	1280	1295	1944	1080	3x474	20x13	501	ø200	755	175	220

# GERF





GERF	Ø mm	L. m
GERF757.5	75	7,5
GERF7510	75	10
GERF7512.5	75	12,5
GERF7515	75	15
GERF1007.5	100	7,5
GERF10010	100	10
GERF10012.5	100	12,5
GERF10015	100	15
GERF1257.5	125	7,5

GERF	Ø mm	L. m
GERF12510	125	10
GERF12512.5	125	12,5
GERF12515	125	15
GERF1507.5	150	7,5
GERF15010	150	10
GERF15012.5	150	12,5
GERF15015	150	15
GERF20010	200	10
GERF20015	200	15

 Arrotolatore motorizzato completo di aspiratore e pulsantiera per aspirazione gas di scarico, completo di tubo flessibile e fermatubo elettrico di sicurezza.

 Electric recoil hose reel with wired push button for exhaust extraction, complete with fan, flexible hose and automatic stopper.

 Enrouleur motorisé avec boîtier à boutons pour l'aspiration des gaz d'échappement, complet avec ventilateur, tuyau flexible et limiteur automatique de fin de course.

 Motorschlauchaufroller mit gekabeltem Drucktaster für die Abgasabsaugung komplett mit Ventilator, Schlauch und automatischem Schlauchstopper.

 Enrollador eléctrico con teclado para aspiración de gas de escape completo de extractor, manguera flexible y parada automática de seguridad.

# GERFT





GERFT	Ø mm	L. m
GERFT757.5	75	7,5
GERFT7510	75	10
GERFT7512.5	75	12,5
GERFT7515	75	15
GERFT1007.5	100	7,5
GERFT10010	100	10
GERFT10012.5	100	12,5
GERFT10015	100	15
GERFT1257.5	125	7,5

GERFT	Ø mm	L. m
GERFT12510	125	10
GERFT12512.5	125	12,5
GERFT12515	125	15
GERFT1507.5	150	7,5
GERFT15010	150	10
GERFT15012.5	150	12,5
GERFT15015	150	15
GERFT20010	200	10
GERFT20015	200	15

 Arrotolatore motorizzato completo di aspiratore e telecomando per aspirazione gas di scarico, completo di tubo flessibile e fermatubo elettrico di sicurezza.

 Electric recoil hose reel with remote control for exhaust extraction, complete with fan, flexible hose and automatic stopper.

 Enrouleur motorisé avec télécommande pour l'aspiration des gaz d'échappement, complet avec ventilateur, tuyau flexible et limiteur automatique de fin de course.

 Motorschlauchaufroller mit Fernbedienung für die Abgasabsaugung komplett mit Ventilator, Schlauch und automatischem Schlauchstopper.

 Enrollador eléctrico con mando para aspiración de gas de escape completo de extractor, manguera flexible y parada automática de seguridad.

# GEMC





GEMC	HP	Phases	Term. Prot.
GEMC	-	3	x
GEMCM	-	1	x
GEMCP-0.5	0,5 HP	3	✓
GEMCP-1	1 HP	3	✓
GEMCP-1.5	1,5 HP	3	✓

 Quadro di partenza e arresto automatico dell'aspiratore collegato direttamente al microinterruttore interno all'arrotolatore.

 Microswitch for the automatic start / stop of the fan integrated in the hose reel.

 Coffret pour le démarrage/arrêt automatique du ventilateur directement connecté au micro interrupteur interne de l'enrouleur.

 Mikroschalter für die automatische Ein/Aus-Schaltung des Ventilators, verbunden an dem Mikroschalter im Motorschlauchaufroller eingebaut.

 Microinterruptor para el arranque y la parada automática del aspirador, conectado directamente al micro interno al enrollador.

# GKSA

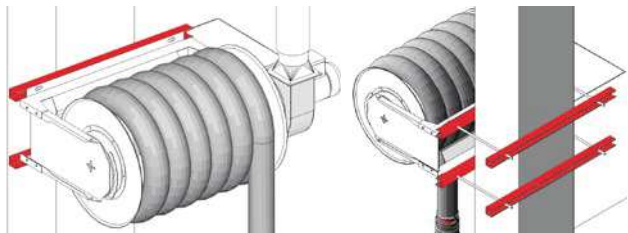



GKSA	Specif.
GKSA	parete / wall / mur / Wand / pared
GKSAC	colonna / pillar / pilier / Säule / columna

 Kit di staffaggio universale per arrotolatori da installare a parete o a colonna.

 Universal fixing kit for hose reels to be placed on weak walls or on columns.

 Kit de support universel pour installer les enrouleurs au mur ou sur une colonne.

 Halterungs-Kit für die Montage des Schlauchaufrollers an einer Wand oder an Säulen.

 Kit de fijación universales para enrolladores instalados a paredes o en columnas.





